

## National Program of Water Supply and Sewerage Systems for Tripoli Region, Libya Tarhunah Settlement

(The Govt. of Libya Funded Project)

## Libya Tarhunah

### Project Brief

The settlement is spread out to an area of 731 Ha with a design population of 39,675 for year 2025. The present population of Tarhunah is about 19,000. The scope of work for infrastructure design consultancy services is the detailed design of Water Supply, Sewerage, Storm Water Drainage systems and Road Works.

### Financing Agency

Govt. of Libya

### Client Name

National Consulting Bureau(NCB), Libya

**Consultancy Fees (USD): US \$ 153543.00**

**Year and Period of consultancy: 2006/07**

### Our Services

- ❖ Review and validation of Technical Studies and Reports
- ❖ Site Verification
- ❖ Design of Water Supply System-Source, Pumping mains, Pumping Stations, Water Treatment, Storage Tanks, Distribution Network
- ❖ Design of Sewerage system-Collection Network, Pumping Stations, Pumping Mains, Sewage Treatment Plants, Treated Water Disposal and Reuse.
- ❖ Design of Storm Water Drainage- Estimation of Rainfall and Run-off, Collection Network, Disposal System-Soakways and Collection Reservoirs.
- ❖ Architectural & Structural Design of Water Supply and Sewerage Systems.
- ❖ Electrical and Mechanical Design of Pumping Stations & Treatment Plants for Watersupply & Sewerage Systems.
- ❖ Preparation of Bill of Quantities and Estimates.
- ❖ Technical Specifications and Tender Documents
- ❖ Technical Training for NCB Engineers.

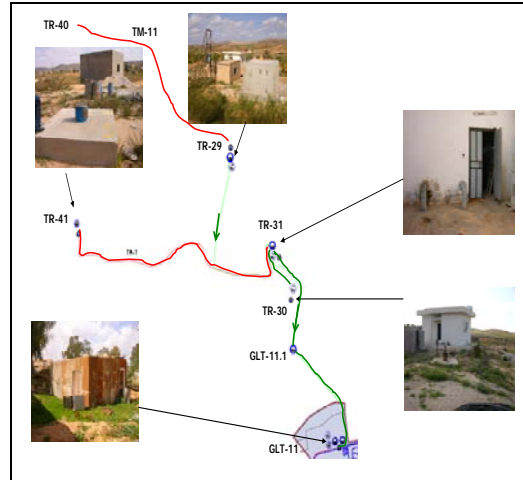

### Existing Water Supply System

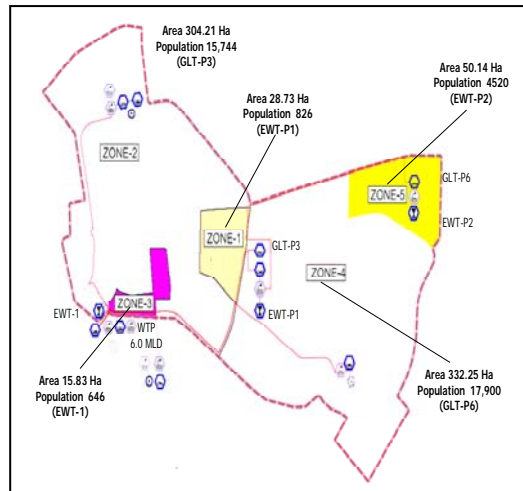

### Water Supply Zones

**TTI Consulting Engineers,**  
32 Newington Technology Park  
8 Avenue of Americas  
Newington NSW 2127  
Sydney, Australia  
Tel: 61 2 96483644  
Fax: 61 2 96483944

**TTI Consulting Engineers(I) Pvt. Ltd,**  
No.5, Shri Maruthi Chambers  
1<sup>st</sup> Main Road, Thimmalah Garden  
R.T. Nagar,  
Bangalore-560 032.  
Tel (+91) 80 26577922  
Fax:(+91) 80 23436022

**TTI Consulting Engineers(I) Pvt Ltd,**  
Delhi Project Office  
DJB Pumping Station  
Opp. Azad Bhawan, I.T.O  
New Delhi-110 002.  
Tel +91-11-23378736  
Fax: +91-11-23378489

**National Program of Water Supply and Sewerage  
Systems for Tripoli Region, Libya  
Qaser Khiyar Settlement**  
(The Govt. of Libya Funded Project)

**Libya  
Qaser Khiyar**

**Project Brief**

The settlement is spread out to an area of 248.17 Ha with a design population of 6,613 for year 2025. The scope of work for infrastructure design consultancy services is the detailed design of Water Supply, Sewerage and Storm Water Drainage systems.

**Financing Agency**

Govt. of Libya

**Client Name**

National Consulting Bureau(NCB), Libya

**Consultancy Fees (USD): US \$ 52115.00**

**Year and Period of consultancy:** 2006/07

**Our Services**

- ❖ Review and validation of Technical Studies and Reports
- ❖ Site Verification
- ❖ Design of Water Supply System-Source, Pumping mains, Pumping Stations, Water Treatment, Storage Tanks, Distribution Network
- ❖ Design of Sewerage system-Collection Network, Pumping Stations, Pumping Mains, Sewage Treatment Plants, Treated Water Disposal and Reuse.
- ❖ Design of Storm water Drainage- Estimation of Rainfall and Run-off, Collection Network, Disposal System-Soakways and Collection Reservoirs.
- ❖ Architectural & Structural Design of Water Supply and Sewerage Systems.
- ❖ Electrical and Mechanical Design of Pumping Stations & Treatment Plants for Watersupply & Sewerage Systems.
- ❖ Preparation of Bill of Quantities and Estimates.
- ❖ Technical Specifications and Tender Documents
- ❖ Technical Training for NCB Engineers.



**Route of GMMR**



**3000mm Dia Pipe in GMMR**

**TTI Consulting Engineers,**  
32 Newington Technology Park  
8 Avenue of Americas  
Newington NSW 2127  
Sydney, Australia  
Tel: 61 2 96483644  
Fax: 61 2 96483944

**TTI Consulting Engineers(I) Pvt. Ltd,**  
No.5, Shri Maruthi Chambers  
1<sup>st</sup> Main Road, Thimmalah Garden  
R.T. Nagar,  
Bangalore-560 032.  
Tel (+91) 80 26577922  
Fax:(+91) 80 23436022

**TTI Consulting Engineers(I) Pvt Ltd,**  
Delhi Project Office  
DJB Pumping Station  
Opp. Azad Bhawan, I.T.O  
New Delhi-110 002.  
Tel +91-11-23378736  
Fax: +91-11-23378489

**National Program of Water Supply and Sewerage Systems for Tripoli Region, Libya**  
**Suk Al Khamis Settlement**  
(The Govt. of Libya Funded Project)

**Libya**  
**Suk Al Khamis**

**Project Brief**

The settlement is spread out to an area of 191.18 Ha with a design population of 6,900 for year 2025. The scope of work for infrastructure design consultancy services is the detailed design of Water Supply, Sewerage and Storm Water Drainage systems.

**Financing Agency**

Govt. of Libya

**Client Name**

National Consulting Bureau(NCB), Libya

**Consultancy Fees (USD): US \$ 40147.00**

**Year and Period of consultancy: 2006/07**

**Our Services**

- ❖ Review and validation of Technical Studies and Reports
- ❖ Site Verification
- ❖ Design of Water Supply System-Source, Pumping mains, Pumping Stations, Water Treatment, Storage Tanks, Distribution Network
- ❖ Design of Sewerage system-Collection Network, Pumping Stations, Pumping Mains, Sewage Treatment Plants, Treated Water Disposal and Reuse.
- ❖ Design of Storm water Drainage- Estimation of Rainfall and Run-off, Collection Network, Disposal System-Soakways and Collection Reservoirs.
- ❖ Architectural & Structural Design of Water Supply and Sewerage Systems.
- ❖ Electrical and Mechanical Design of Pumping Stations & Treatment Plants for Watersupply & Sewerage Systems.
- ❖ Preparation of Bill of Quantities and Estimates.
- ❖ Technical Specifications and Tender Documents
- ❖ Technical Training for NCB Engineers.

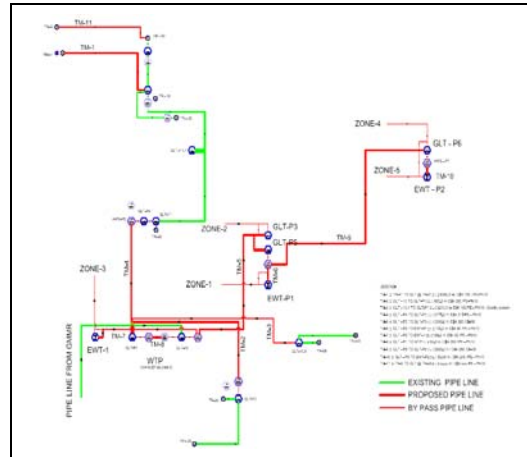

**Schematic layout of proposed Water Supply System**

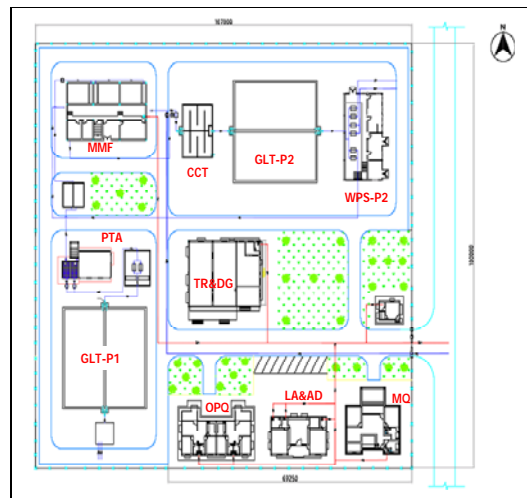

**Water Treatment Plant: Layout**

**TTI Consulting Engineers,**  
32 Newington Technology Park  
8 Avenue of Americas  
Newington NSW 2127  
Sydney, Australia  
Tel: 61 2 96483644  
Fax: 61 2 96483944

**TTI Consulting Engineers(I) Pvt. Ltd,**  
No.5, Shri Maruthi Chambers  
1<sup>st</sup> Main Road, Thimmalah Garden  
R.T. Nagar,  
Bangalore-560 032.  
Tel (+91) 80 26577922  
Fax:(+91) 80 23436022

**TTI Consulting Engineers(I) Pvt Ltd,**  
Delhi Project Office  
DJB Pumping Station  
Opp. Azad Bhawan, I.T.O  
New Delhi-110 002.  
Tel +91-11-23378736  
Fax: +91-11-23378489

## National Program of Water Supply and Sewerage Systems for Tripoli Region, Libya

### Miskah Settlement

(The Govt. of Libya Funded Project)

**Libya**  
**Miskah**

#### Project Brief

The settlement is spread out to an area of 6.81 Ha with a design population of 345 for year 2025. The scope of work for infrastructure design consultancy services is the detailed design of Water Supply, Sewerage and Storm Water Drainage systems.

#### Financing Agency

Govt. of Libya

#### Client Name

National Consulting Bureau(NCB), Libya

**Consultancy Fees (USD): US \$ 1430.00**

**Year and Period of consultancy: 2006/07**

#### Our Services

- ❖ Review and validation of Technical Studies and Reports
- ❖ Site Verification
- ❖ Design of Water Supply System-Source, Pumping mains, Pumping Stations, Water Treatment, Storage Tanks, Distribution Network
- ❖ Design of Sewerage system-Collection Network, Pumping Stations, Pumping Mains, Sewage Treatment Plants, Treated Water Disposal and Reuse.
- ❖ Design of Storm water Drainage- Estimation of Rainfall and Run-off, Collection Network, Disposal System-Soakways and Collection Reservoirs.
- ❖ Architectural & Structural Design of Water Supply and Sewerage Systems.
- ❖ Electrical and Mechanical Design of Pumping Stations & Treatment Plants for Watersupply & Sewerage Systems.
- ❖ Preparation of Bill of Quantities and Estimates.
- ❖ Technical Specifications and Tender Documents
- ❖ Technical Training for NCB Engineers.

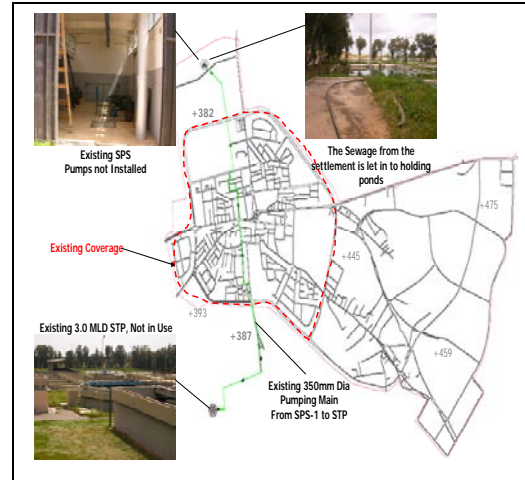

**Existing Sewerage System**

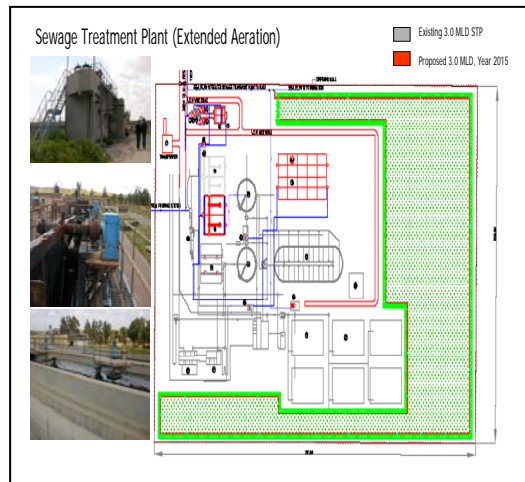

**Sewage Treatment Plant**

**TTI Consulting Engineers,**  
32 Newington Technology Park  
8 Avenue of Americas  
Newington NSW 2127  
Sydney, Australia  
Tel: 61 2 96483644  
Fax: 61 2 96483944

**TTI Consulting Engineers(I) Pvt. Ltd,**  
No.5, Shri Maruthi Chambers  
1<sup>st</sup> Main Road, Thimmalah Garden  
R.T. Nagar,  
Bangalore-560 032.  
Tel (+91) 80 26577922  
Fax:(+91) 80 23436022

**TTI Consulting Engineers(I) Pvt Ltd,**  
Delhi Project Office  
DJB Pumping Station  
Opp. Azad Bhawan, I.T.O  
New Delhi-110 002.  
Tel +91-11-23378736  
Fax: +91-11-23378489

## National Program of Water Supply and Sewerage Systems for Tripoli Region, Libya Esbeya Settlement

(The Govt. of Libya Funded Project)

Libya  
Esbeya

### Project Brief

The settlement is spread out to an area of 154.03 Ha with a design population of 2929 for year 2025. The scope of work for infrastructure design consultancy services is the detailed design of Water Supply, Sewerage and Storm Water Drainage systems.

### Financing Agency

Govt. of Libya

### Client Name

National Consulting Bureau(NCB), Libya

**Consultancy Fees (USD): US \$ 32346.00**

**Year and Period of consultancy:** 2006/07

### Our Services

- ❖ Review and validation of Technical Studies and Reports
- ❖ Site Verification
- ❖ Design of Water Supply System-Source, Pumping mains, Pumping Stations, Water Treatment, Storage Tanks, Distribution Network
- ❖ Design of Sewerage system-Collection Network, Pumping Stations, Pumping Mains, Sewage Treatment Plants, Treated Water Disposal and Reuse.
- ❖ Design of Storm water Drainage- Estimation of Rainfall and Run-off, Collection Network, Disposal System-Soakways and Collection Reservoirs.
- ❖ Architectural & Structural Design of Water Supply and Sewerage Systems.
- ❖ Electrical and Mechanical Design of Pumping Stations & Treatment Plants for Watersupply & Sewerage Systems.
- ❖ Preparation of Bill of Quantities and Estimates.
- ❖ Technical Specifications and Tender Documents
- ❖ Technical Training for NCB Engineers.



Existing Water supply valve chamber



Corroded valve chamber

TTI Consulting Engineers,  
32 Newington Technology Park  
8 Avenue of Americas  
Newington NSW 2127  
Sydney, Australia  
Tel: 61 2 96483644  
Fax: 61 2 96483944

TTI Consulting Engineers(I) Pvt. Ltd,  
No.5, Shri Maruthi Chambers  
1<sup>st</sup> Main Road, Thimmalah Garden  
R.T. Nagar,  
Bangalore-560 032.  
Tel (+91) 80 26577922  
Fax:(+91) 80 23436022

TTI Consulting Engineers(I) Pvt Ltd,  
Delhi Project Office  
DJB Pumping Station  
Opp. Azad Bhawan, I.T.O  
New Delhi-110 002.  
Tel +91-11-23378736  
Fax: +91-11-23378489

## National Program of Water Supply and Sewerage Systems for Tripoli Region, Libya Bin Gashir Settlement

(The Govt. of Libya Funded Project)

Libya  
Bin Gashir

### Project Brief

The settlement is spread out to an area of 334.02 Ha with a design population of 19838 for year 2025. The scope of work for infrastructure design consultancy services is the detailed design of Water Supply, Sewerage and Storm Water Drainage systems.

### Financing Agency

Govt. of Libya

### Client Name

National Consulting Bureau(NCB), Libya

**Consultancy Fees (USD): US \$ 70144.00**

**Year and Period of consultancy:** 2006/07

### Our Services

- ❖ Review and validation of Technical Studies and Reports
- ❖ Site Verification
- ❖ Design of Water Supply System-Source, Pumping mains, Pumping Stations, Water Treatment, Storage Tanks, Distribution Network
- ❖ Design of Sewerage system-Collection Network, Pumping Stations, Pumping Mains, Sewage Treatment Plants, Treated Water Disposal and Reuse.
- ❖ Design of Storm water Drainage- Estimation of Rainfall and Run-off, Collection Network, Disposal System-Soakways and Collection Reservoirs.
- ❖ Architectural & Structural Design of Water Supply and Sewerage Systems.
- ❖ Electrical and Mechanical Design of Pumping Stations & Treatment Plants for Watersupply & Sewerage Systems.
- ❖ Preparation of Bill of Quantities and Estimates.
- ❖ Technical Specifications and Tender Documents
- ❖ Technical Training for NCB Engineers.



**Sewage Stagnation in open Drain**



**Sewage over flowing on street**

TTI Consulting Engineers,  
32 Newington Technology Park  
8 Avenue of Americas  
Newington NSW 2127  
Sydney, Australia  
Tel: 61 2 96483644  
Fax: 61 2 96483944

TTI Consulting Engineers(I) Pvt. Ltd,  
No.5, Shri Maruthi Chambers  
1<sup>st</sup> Main Road, Thimmalah Garden  
R.T. Nagar,  
Bangalore-560 032.  
Tel (+91) 80 26577922  
Fax:(+91) 80 23436022

TTI Consulting Engineers(I) Pvt Ltd,  
Delhi Project Office  
DJB Pumping Station  
Opp. Azad Bhawan, I.T.O  
New Delhi-110 002.  
Tel +91-11-23378736  
Fax: +91-11-23378489

## National Program of Water Supply and Sewerage Systems for Tripoli Region, Libya Al Khums Settlement

(The Govt. of Libya Funded Project)

Libya  
Al Khums

### Project Brief

The settlement is spread out to an area of 1742 Ha with a design population of 92575 for year 2025. The scope of work for infrastructure design consultancy services is the detailed design of Water Supply, Sewerage and Storm Water Drainage systems.

### Financing Agency

Govt. of Libya

### Client Name

National Consulting Bureau(NCB), Libya

**Consultancy Fees (USD): US \$ 365820**

**Year and Period of consultancy:** 2006/07

### Our Services

- ❖ Review and validation of Technical Studies and Reports
- ❖ Site Verification
- ❖ Design of Water Supply System-Source, Pumping mains, Pumping Stations, Water Treatment, Storage Tanks, Distribution Network
- ❖ Design of Sewerage system-Collection Network, Pumping Stations, Pumping Mains, Sewage Treatment Plants, Treated Water Disposal and Reuse.
- ❖ Design of Storm water Drainage- Estimation of Rainfall and Run-off, Collection Network, Disposal System-Soakways and Collection Reservoirs.
- ❖ Architectural & Structural Design of Water Supply and Sewerage Systems.
- ❖ Electrical and Mechanical Design of Pumping Stations & Treatment Plants for Watersupply & Sewerage Systems.
- ❖ Preparation of Bill of Quantities and Estimates.
- ❖ Technical Specifications and Tender Documents
- ❖ Technical Training for NCB Engineers.



Existing Sewerage System



Existing GLRS

TTI Consulting Engineers,  
32 Newington Technology Park  
8 Avenue of Americas  
Newington NSW 2127  
Sydney, Australia  
Tel: 61 2 96483644  
Fax: 61 2 96483944

TTI Consulting Engineers(I) Pvt. Ltd,  
No.5, Shri Maruthi Chambers  
1<sup>st</sup> Main Road, Thimmalah Garden  
R.T. Nagar,  
Bangalore-560 032.  
Tel (+91) 80 26577922  
Fax:(+91) 80 23436022

TTI Consulting Engineers(I) Pvt Ltd,  
Delhi Project Office  
DJB Pumping Station  
Opp. Azad Bhawan, I.T.O  
New Delhi-110 002.  
Tel +91-11-23378736  
Fax: +91-11-23378489

## National Program of Water Supply and Sewerage Systems for Tripoli Region, Libya Yifren Settlement

(The Govt. of Libya Funded Project)

**Libya**  
**Yifren**

### Project Brief

The settlement is spread out to an area of 242.97 Ha with a design population of 13800 for year 2025. The scope of work for infrastructure design consultancy services is the detailed design of Water Supply, Sewerage and Storm Water Drainage systems.

### Financing Agency

Govt. of Libya

### Client Name

National Consulting Bureau(NCB), Libya

**Consultancy Fees (USD): US \$ 51023.00**

**Year and Period of consultancy: 2006/07**

### Our Services

- ❖ Review and validation of Technical Studies and Reports
- ❖ Site Verification
- ❖ Design of Water Supply System-Source, Pumping mains, Pumping Stations, Water Treatment, Storage Tanks, Distribution Network
- ❖ Design of Sewerage system-Collection Network, Pumping Stations, Pumping Mains, Sewage Treatment Plants, Treated Water Disposal and Reuse.
- ❖ Design of Storm water Drainage- Estimation of Rainfall and Run-off, Collection Network, Disposal System-Soakways and Collection Reservoirs.
- ❖ Architectural & Structural Design of Water Supply and Sewerage Systems.
- ❖ Electrical and Mechanical Design of Pumping Stations & Treatment Plants for Watersupply & Sewerage Systems.
- ❖ Preparation of Bill of Quantities and Estimates.
- ❖ Technical Specifications and Tender Documents
- ❖ Technical Training for NCB Engineers.

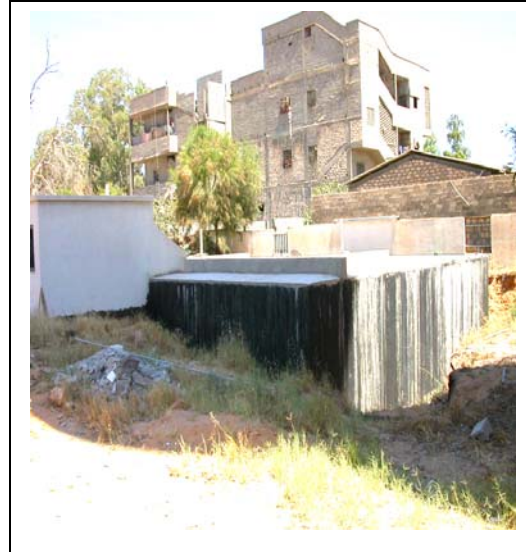

**GLT-200 cum capacity**



**Existing Borewell**

**TTI Consulting Engineers,**  
32 Newington Technology Park  
8 Avenue of Americas  
Newington NSW 2127  
Sydney, Australia  
Tel: 61 2 96483644  
Fax: 61 2 96483944

**TTI Consulting Engineers(I) Pvt. Ltd,**  
No.5, Shri Maruthi Chambers  
1<sup>st</sup> Main Road, Thimmalah Garden  
R.T. Nagar,  
Bangalore-560 032.  
Tel (+91) 80 26577922  
Fax:(+91) 80 23436022

**TTI Consulting Engineers(I) Pvt Ltd,**  
Delhi Project Office  
DJB Pumping Station  
Opp. Azad Bhawan, I.T.O  
New Delhi-110 002.  
Tel +91-11-23378736  
Fax: +91-11-23378489

## National Program of Water Supply and Sewerage Systems for Tripoli Region, Libya Gharyana Settlement

(The Govt. of Libya Funded Project)

Libya  
Gharyana

### Project Brief

The settlement is spread out to an area of 458.22 Ha with a design population of 33063 for year 2025. The scope of work for infrastructure design consultancy services is the detailed design of Water Supply, Sewerage and Storm Water Drainage systems.

### Financing Agency

Govt. of Libya

### Client Name

National Consulting Bureau(NCB), Libya

**Consultancy Fees (USD): US \$ 128324.00**

**Year and Period of consultancy: 2006/07**

### Our Services

- ❖ Review and validation of Technical Studies and Reports
- ❖ Site Verification
- ❖ Design of Water Supply System-Source, Pumping mains, Pumping Stations, Water Treatment, Storage Tanks, Distribution Network
- ❖ Design of Sewerage system-Collection Network, Pumping Stations, Pumping Mains, Sewage Treatment Plants, Treated Water Disposal and Reuse.
- ❖ Design of Storm water Drainage- Estimation of Rainfall and Run-off, Collection Network, Disposal System-Soakways and Collection Reservoirs.
- ❖ Architectural & Structural Design of Water Supply and Sewerage Systems.
- ❖ Electrical and Mechanical Design of Pumping Stations & Treatment Plants for Watersupply & Sewerage Systems.
- ❖ Preparation of Bill of Quantities and Estimates.
- ❖ Technical Specifications and Tender Documents
- ❖ Technical Training for NCB Engineers.



Existing Reservoir



Existing Drainage System

TTI Consulting Engineers,  
32 Newington Technology Park  
8 Avenue of Americas  
Newington NSW 2127  
Sydney, Australia  
Tel: 61 2 96483644  
Fax: 61 2 96483944

TTI Consulting Engineers(I) Pvt. Ltd,  
No.5, Shri Maruthi Chambers  
1<sup>st</sup> Main Road, Thimmalah Garden  
R.T. Nagar,  
Bangalore-560 032.  
Tel (+91) 80 26577922  
Fax:(+91) 80 23436022

TTI Consulting Engineers(I) Pvt Ltd,  
Delhi Project Office  
DJB Pumping Station  
Opp. Azad Bhawan, I.T.O  
New Delhi-110 002.  
Tel +91-11-23378736  
Fax: +91-11-23378489

**National Program of Water Supply and Sewerage  
Systems for Tripoli Region, Libya  
Qaser Khiyar Settlement**  
(The Govt. of Libya Funded Project)

**Libya  
Qaser Khiyar**

**Project Brief**

The settlement is spread out to an area of 248.17 Ha with a design population of 6,613 for year 2025. The scope of work for infrastructure design consultancy services is the detailed design of Water Supply, Sewerage and Storm Water Drainage systems.

**Financing Agency**

Govt. of Libya

**Client Name**

National Consulting Bureau(NCB), Libya

**Consultancy Fees (USD): US \$ 52115.00**

**Year and Period of consultancy:** 2006/07

**Our Services**

- ❖ Review and validation of Technical Studies and Reports
- ❖ Site Verification
- ❖ Design of Water Supply System-Source, Pumping mains, Pumping Stations, Water Treatment, Storage Tanks, Distribution Network
- ❖ Design of Sewerage system-Collection Network, Pumping Stations, Pumping Mains, Sewage Treatment Plants, Treated Water Disposal and Reuse.
- ❖ Design of Storm water Drainage- Estimation of Rainfall and Run-off, Collection Network, Disposal System-Soakways and Collection Reservoirs.
- ❖ Architectural & Structural Design of Water Supply and Sewerage Systems.
- ❖ Electrical and Mechanical Design of Pumping Stations & Treatment Plants for Watersupply & Sewerage Systems.
- ❖ Preparation of Bill of Quantities and Estimates.
- ❖ Technical Specifications and Tender Documents
- ❖ Technical Training for NCB Engineers.



**Route of GMMR**



**3000mm Dia Pipe in GMMR**

**TTI Consulting Engineers,**  
32 Newington Technology Park  
8 Avenue of Americas  
Newington NSW 2127  
Sydney, Australia  
Tel: 61 2 96483644  
Fax: 61 2 96483944

**TTI Consulting Engineers(I) Pvt. Ltd,**  
No.5, Shri Maruthi Chambers  
1<sup>st</sup> Main Road, Thimmalah Garden  
R.T. Nagar,  
Bangalore-560 032.  
Tel (+91) 80 26577922  
Fax:(+91) 80 23436022

**TTI Consulting Engineers(I) Pvt Ltd,**  
Delhi Project Office  
DJB Pumping Station  
Opp. Azad Bhawan, I.T.O  
New Delhi-110 002.  
Tel +91-11-23378736  
Fax: +91-11-23378489

## National Program of Water Supply and Sewerage Systems for Tripoli Region, Libya Misllatah Settlement

(The Govt. of Libya Funded Project)

Libya  
Misllatah

### Project Brief

The settlement is spread out to an area of 458.22 Ha with a design population of 33063 for year 2025. The scope of work for infrastructure design consultancy services is the detailed design of Water Supply, Sewerage and Storm Water Drainage systems.

### Financing Agency

Govt. of Libya

### Client Name

National Consulting Bureau(NCB), Libya

**Consultancy Fees (USD): US \$ 96226.2**

**Year and Period of consultancy: 2006/07**

### Our Services

- ❖ Review and validation of Technical Studies and Reports
- ❖ Site Verification
- ❖ Design of Water Supply System-Source, Pumping mains, Pumping Stations, Water Treatment, Storage Tanks, Distribution Network
- ❖ Design of Sewerage system-Collection Network, Pumping Stations, Pumping Mains, Sewage Treatment Plants, Treated Water Disposal and Reuse.
- ❖ Design of Storm water Drainage- Estimation of Rainfall and Run-off, Collection Network, Disposal System-Soakways and Collection Reservoirs.
- ❖ Architectural & Structural Design of Water Supply and Sewerage Systems.
- ❖ Electrical and Mechanical Design of Pumping Stations & Treatment Plants for Watersupply & Sewerage Systems.
- ❖ Preparation of Bill of Quantities and Estimates.
- ❖ Technical Specifications and Tender Documents
- ❖ Technical Training for NCB Engineers.



**GMMR, Turnout**



**Existing outlet pipes**

TTI Consulting Engineers,  
32 Newington Technology Park  
8 Avenue of Americas  
Newington NSW 2127  
Sydney, Australia  
Tel: 61 2 96483644  
Fax: 61 2 96483944

TTI Consulting Engineers(I) Pvt. Ltd,  
No.5, Shri Maruthi Chambers  
1<sup>st</sup> Main Road, Thimmalah Garden  
R.T. Nagar,  
Bangalore-560 032.  
Tel (+91) 80 26577922  
Fax:(+91) 80 23436022

TTI Consulting Engineers(I) Pvt Ltd,  
Delhi Project Office  
DJB Pumping Station  
Opp. Azad Bhawan, I.T.O  
New Delhi-110 002.  
Tel +91-11-23378736  
Fax: +91-11-23378489

**National Program of Water Supply and Sewerage Systems for Tripoli Region, Libya**  
**Miskah Settlement**

(The Govt. of Libya Funded Project)

**Libya**  
**Miskah**

**Project Brief**

The settlement is spread out to an area of 6.81 Ha with a design population of 345 for year 2025. The scope of work for infrastructure design consultancy services is the detailed design of Water Supply, Sewerage and Storm Water Drainage systems.

**Financing Agency**

Govt. of Libya

**Client Name**

National Consulting Bureau(NCB), Libya

**Consultancy Fees (USD): US \$ 1430.00**

**Year and Period of consultancy: 2006/07**

**Our Services**

- ❖ Review and validation of Technical Studies and Reports
- ❖ Site Verification
- ❖ Design of Water Supply System-Source, Pumping mains, Pumping Stations, Water Treatment, Storage Tanks, Distribution Network
- ❖ Design of Sewerage system-Collection Network, Pumping Stations, Pumping Mains, Sewage Treatment Plants, Treated Water Disposal and Reuse.
- ❖ Design of Storm water Drainage- Estimation of Rainfall and Run-off, Collection Network, Disposal System-Soakways and Collection Reservoirs.
- ❖ Architectural & Structural Design of Water Supply and Sewerage Systems.
- ❖ Electrical and Mechanical Design of Pumping Stations & Treatment Plants for Watersupply & Sewerage Systems.
- ❖ Preparation of Bill of Quantities and Estimates.
- ❖ Technical Specifications and Tender Documents
- ❖ Technical Training for NCB Engineers.

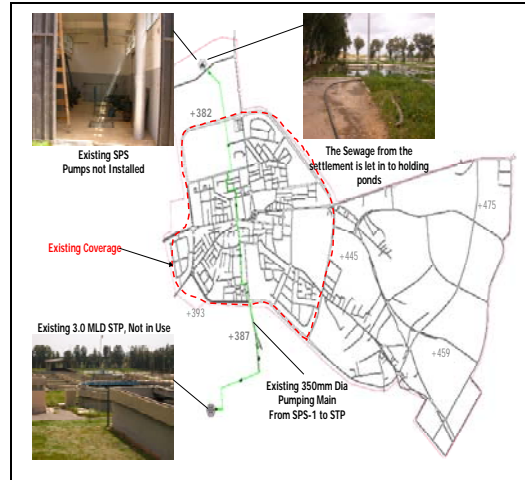

**Existing Sewerage System**



**Sewage Treatment Plant**

**TTI Consulting Engineers,**  
32 Newington Technology Park  
8 Avenue of Americas  
Newington NSW 2127  
Sydney, Australia  
Tel: 61 2 96483644  
Fax: 61 2 96483944

**TTI Consulting Engineers(I) Pvt. Ltd,**  
No.5, Shri Maruthi Chambers  
1<sup>st</sup> Main Road, Thimmalah Garden  
R.T. Nagar,  
Bangalore-560 032.  
Tel (+91) 80 26577922  
Fax:(+91) 80 23436022

**TTI Consulting Engineers(I) Pvt Ltd,**  
Delhi Project Office  
DJB Pumping Station  
Opp. Azad Bhawan, I.T.O  
New Delhi-110 002.  
Tel +91-11-23378736  
Fax: +91-11-23378489

## National Program of Water Supply and Sewerage Systems for Tripoli Region, Libya Esbeya Settlement

(The Govt. of Libya Funded Project)

Libya  
Esbeya

### Project Brief

The settlement is spread out to an area of 154.03 Ha with a design population of 2929 for year 2025. The scope of work for infrastructure design consultancy services is the detailed design of Water Supply, Sewerage and Storm Water Drainage systems.

### Financing Agency

Govt. of Libya

### Client Name

National Consulting Bureau(NCB), Libya

**Consultancy Fees (USD): US \$ 32346.00**

**Year and Period of consultancy:** 2006/07

### Our Services

- ❖ Review and validation of Technical Studies and Reports
- ❖ Site Verification
- ❖ Design of Water Supply System-Source, Pumping mains, Pumping Stations, Water Treatment, Storage Tanks, Distribution Network
- ❖ Design of Sewerage system-Collection Network, Pumping Stations, Pumping Mains, Sewage Treatment Plants, Treated Water Disposal and Reuse.
- ❖ Design of Storm water Drainage- Estimation of Rainfall and Run-off, Collection Network, Disposal System-Soakways and Collection Reservoirs.
- ❖ Architectural & Structural Design of Water Supply and Sewerage Systems.
- ❖ Electrical and Mechanical Design of Pumping Stations & Treatment Plants for Watersupply & Sewerage Systems.
- ❖ Preparation of Bill of Quantities and Estimates.
- ❖ Technical Specifications and Tender Documents
- ❖ Technical Training for NCB Engineers.



Existing Water supply valve chamber



Corroded valve chamber

TTI Consulting Engineers,  
32 Newington Technology Park  
8 Avenue of Americas  
Newington NSW 2127  
Sydney, Australia  
Tel: 61 2 96483644  
Fax: 61 2 96483944

TTI Consulting Engineers(I) Pvt. Ltd,  
No.5, Shri Maruthi Chambers  
1<sup>st</sup> Main Road, Thimmalah Garden  
R.T. Nagar,  
Bangalore-560 032.  
Tel (+91) 80 26577922  
Fax:(+91) 80 23436022

TTI Consulting Engineers(I) Pvt Ltd,  
Delhi Project Office  
DJB Pumping Station  
Opp. Azad Bhawan, I.T.O  
New Delhi-110 002.  
Tel +91-11-23378736  
Fax: +91-11-23378489

## National Program of Water Supply and Sewerage Systems for Tripoli Region, Libya Bin Gashir Settlement

(The Govt. of Libya Funded Project)

Libya  
Bin Gashir

### Project Brief

The settlement is spread out to an area of 334.02 Ha with a design population of 19838 for year 2025. The scope of work for infrastructure design consultancy services is the detailed design of Water Supply, Sewerage and Storm Water Drainage systems.

### Financing Agency

Govt. of Libya

### Client Name

National Consulting Bureau(NCB), Libya

**Consultancy Fees (USD): US \$ 70144.00**

**Year and Period of consultancy:** 2006/07

### Our Services

- ❖ Review and validation of Technical Studies and Reports
- ❖ Site Verification
- ❖ Design of Water Supply System-Source, Pumping mains, Pumping Stations, Water Treatment, Storage Tanks, Distribution Network
- ❖ Design of Sewerage system-Collection Network, Pumping Stations, Pumping Mains, Sewage Treatment Plants, Treated Water Disposal and Reuse.
- ❖ Design of Storm water Drainage- Estimation of Rainfall and Run-off, Collection Network, Disposal System-Soakways and Collection Reservoirs.
- ❖ Architectural & Structural Design of Water Supply and Sewerage Systems.
- ❖ Electrical and Mechanical Design of Pumping Stations & Treatment Plants for Watersupply & Sewerage Systems.
- ❖ Preparation of Bill of Quantities and Estimates.
- ❖ Technical Specifications and Tender Documents
- ❖ Technical Training for NCB Engineers.



**Sewage Stagnation in open Drain**

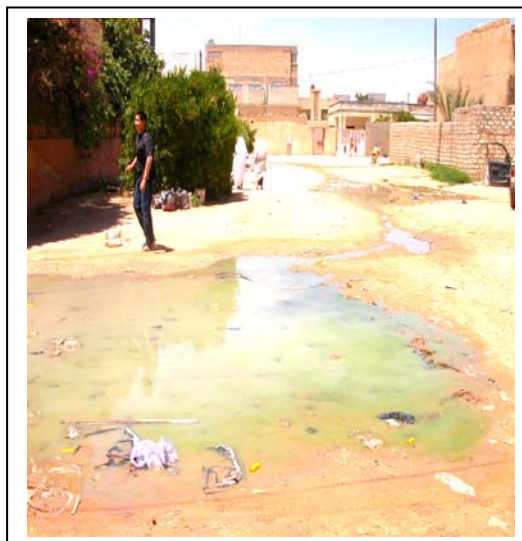

**Sewage over flowing on street**

TTI Consulting Engineers,  
32 Newington Technology Park  
8 Avenue of Americas  
Newington NSW 2127  
Sydney, Australia  
Tel: 61 2 96483644  
Fax: 61 2 96483944

TTI Consulting Engineers(I) Pvt. Ltd,  
No.5, Shri Maruthi Chambers  
1<sup>st</sup> Main Road, Thimmalah Garden  
R.T. Nagar,  
Bangalore-560 032.  
Tel (+91) 80 26577922  
Fax:(+91) 80 23436022

TTI Consulting Engineers(I) Pvt Ltd,  
Delhi Project Office  
DJB Pumping Station  
Opp. Azad Bhawan, I.T.O  
New Delhi-110 002.  
Tel +91-11-23378736  
Fax: +91-11-23378489

## National Program of Water Supply and Sewerage Systems for Tripoli Region, Libya Al Khums Settlement

(The Govt. of Libya Funded Project)

Libya  
Al Khums

### Project Brief

The settlement is spread out to an area of 1742 Ha with a design population of 92575 for year 2025. The scope of work for infrastructure design consultancy services is the detailed design of Water Supply, Sewerage and Storm Water Drainage systems.

### Financing Agency

Govt. of Libya

### Client Name

National Consulting Bureau(NCB), Libya

**Consultancy Fees (USD): US \$ 365820**

**Year and Period of consultancy:** 2006/07

### Our Services

- ❖ Review and validation of Technical Studies and Reports
- ❖ Site Verification
- ❖ Design of Water Supply System-Source, Pumping mains, Pumping Stations, Water Treatment, Storage Tanks, Distribution Network
- ❖ Design of Sewerage system-Collection Network, Pumping Stations, Pumping Mains, Sewage Treatment Plants, Treated Water Disposal and Reuse.
- ❖ Design of Storm water Drainage- Estimation of Rainfall and Run-off, Collection Network, Disposal System-Soakways and Collection Reservoirs.
- ❖ Architectural & Structural Design of Water Supply and Sewerage Systems.
- ❖ Electrical and Mechanical Design of Pumping Stations & Treatment Plants for Watersupply & Sewerage Systems.
- ❖ Preparation of Bill of Quantities and Estimates.
- ❖ Technical Specifications and Tender Documents
- ❖ Technical Training for NCB Engineers.



Existing Sewerage System



Existing GLRS

TTI Consulting Engineers,  
32 Newington Technology Park  
8 Avenue of Americas  
Newington NSW 2127  
Sydney, Australia  
Tel: 61 2 96483644  
Fax: 61 2 96483944

TTI Consulting Engineers(I) Pvt. Ltd,  
No.5, Shri Maruthi Chambers  
1<sup>st</sup> Main Road, Thimmalah Garden  
R.T. Nagar,  
Bangalore-560 032.  
Tel (+91) 80 26577922  
Fax:(+91) 80 23436022

TTI Consulting Engineers(I) Pvt Ltd,  
Delhi Project Office  
DJB Pumping Station  
Opp. Azad Bhawan, I.T.O  
New Delhi-110 002.  
Tel +91-11-23378736  
Fax: +91-11-23378489

## National Program of Water Supply and Sewerage Systems for Tripoli Region, Libya Yifren Settlement

(The Govt. of Libya Funded Project)

Libya  
Yifren

### Project Brief

The settlement is spread out to an area of 242.97 Ha with a design population of 13800 for year 2025. The scope of work for infrastructure design consultancy services is the detailed design of Water Supply, Sewerage and Storm Water Drainage systems.

### Financing Agency

Govt. of Libya

### Client Name

National Consulting Bureau(NCB), Libya

**Consultancy Fees (USD): US \$ 51023.00**

**Year and Period of consultancy:** 2006/07

### Our Services

- ❖ Review and validation of Technical Studies and Reports
- ❖ Site Verification
- ❖ Design of Water Supply System-Source, Pumping mains, Pumping Stations, Water Treatment, Storage Tanks, Distribution Network
- ❖ Design of Sewerage system-Collection Network, Pumping Stations, Pumping Mains, Sewage Treatment Plants, Treated Water Disposal and Reuse.
- ❖ Design of Storm water Drainage- Estimation of Rainfall and Run-off, Collection Network, Disposal System-Soakways and Collection Reservoirs.
- ❖ Architectural & Structural Design of Water Supply and Sewerage Systems.
- ❖ Electrical and Mechanical Design of Pumping Stations & Treatment Plants for Watersupply & Sewerage Systems.
- ❖ Preparation of Bill of Quantities and Estimates.
- ❖ Technical Specifications and Tender Documents
- ❖ Technical Training for NCB Engineers.

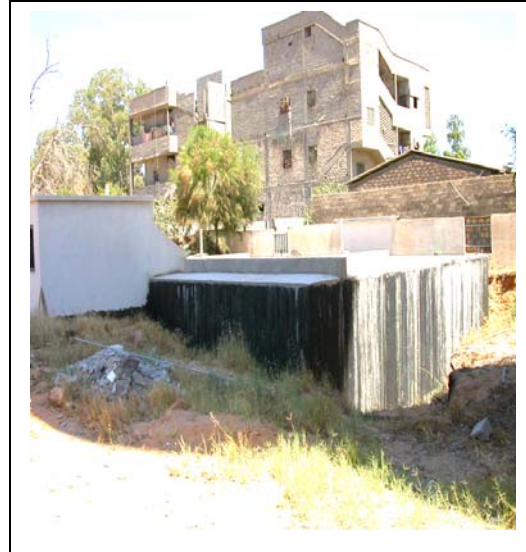

GLT-200 cum capacity



Existing Borewell

TTI Consulting Engineers,  
32 Newington Technology Park  
8 Avenue of Americas  
Newington NSW 2127  
Sydney, Australia  
Tel: 61 2 96483644  
Fax: 61 2 96483944

TTI Consulting Engineers(I) Pvt. Ltd,  
No.5, Shri Maruthi Chambers  
1<sup>st</sup> Main Road, Thimmalah Garden  
R.T. Nagar,  
Bangalore-560 032.  
Tel (+91) 80 26577922  
Fax:(+91) 80 23436022

TTI Consulting Engineers(I) Pvt Ltd,  
Delhi Project Office  
DJB Pumping Station  
Opp. Azad Bhawan, I.T.O  
New Delhi-110 002.  
Tel +91-11-23378736  
Fax: +91-11-23378489

## National Program of Water Supply and Sewerage Systems for Tripoli Region, Libya Gharyana Settlement

(The Govt. of Libya Funded Project)

Libya  
Gharyana

### Project Brief

The settlement is spread out to an area of 458.22 Ha with a design population of 33063 for year 2025. The scope of work for infrastructure design consultancy services is the detailed design of Water Supply, Sewerage and Storm Water Drainage systems.

### Financing Agency

Govt. of Libya

### Client Name

National Consulting Bureau(NCB), Libya

**Consultancy Fees (USD): US \$ 128324.00**

**Year and Period of consultancy: 2006/07**

### Our Services

- ❖ Review and validation of Technical Studies and Reports
- ❖ Site Verification
- ❖ Design of Water Supply System-Source, Pumping mains, Pumping Stations, Water Treatment, Storage Tanks, Distribution Network
- ❖ Design of Sewerage system-Collection Network, Pumping Stations, Pumping Mains, Sewage Treatment Plants, Treated Water Disposal and Reuse.
- ❖ Design of Storm water Drainage- Estimation of Rainfall and Run-off, Collection Network, Disposal System-Soakways and Collection Reservoirs.
- ❖ Architectural & Structural Design of Water Supply and Sewerage Systems.
- ❖ Electrical and Mechanical Design of Pumping Stations & Treatment Plants for Watersupply & Sewerage Systems.
- ❖ Preparation of Bill of Quantities and Estimates.
- ❖ Technical Specifications and Tender Documents
- ❖ Technical Training for NCB Engineers.



Existing Reservoir



Existing Drainage System

TTI Consulting Engineers,  
32 Newington Technology Park  
8 Avenue of Americas  
Newington NSW 2127  
Sydney, Australia  
Tel: 61 2 96483644  
Fax: 61 2 96483944

TTI Consulting Engineers(I) Pvt. Ltd,  
No.5, Shri Maruthi Chambers  
1<sup>st</sup> Main Road, Thimmalah Garden  
R.T. Nagar,  
Bangalore-560 032.  
Tel (+91) 80 26577922  
Fax:(+91) 80 23436022

TTI Consulting Engineers(I) Pvt Ltd,  
Delhi Project Office  
DJB Pumping Station  
Opp. Azad Bhawan, I.T.O  
New Delhi-110 002.  
Tel +91-11-23378736  
Fax: +91-11-23378489

## National Program of Water Supply and Sewerage Systems for Tripoli Region, Libya Misllatah Settlement

(The Govt. of Libya Funded Project)

Libya  
Misllatah

### Project Brief

The settlement is spread out to an area of 458.22 Ha with a design population of 33063 for year 2025. The scope of work for infrastructure design consultancy services is the detailed design of Water Supply, Sewerage and Storm Water Drainage systems.

### Financing Agency

Govt. of Libya

### Client Name

National Consulting Bureau(NCB), Libya

**Consultancy Fees (USD): US \$ 96226.2**

**Year and Period of consultancy: 2006/07**

### Our Services

- ❖ Review and validation of Technical Studies and Reports
- ❖ Site Verification
- ❖ Design of Water Supply System-Source, Pumping mains, Pumping Stations, Water Treatment, Storage Tanks, Distribution Network
- ❖ Design of Sewerage system-Collection Network, Pumping Stations, Pumping Mains, Sewage Treatment Plants, Treated Water Disposal and Reuse.
- ❖ Design of Storm water Drainage- Estimation of Rainfall and Run-off, Collection Network, Disposal System-Soakways and Collection Reservoirs.
- ❖ Architectural & Structural Design of Water Supply and Sewerage Systems.
- ❖ Electrical and Mechanical Design of Pumping Stations & Treatment Plants for Watersupply & Sewerage Systems.
- ❖ Preparation of Bill of Quantities and Estimates.
- ❖ Technical Specifications and Tender Documents
- ❖ Technical Training for NCB Engineers.



**GMMR, Turnout**



**Existing outlet pipes**

TTI Consulting Engineers,  
32 Newington Technology Park  
8 Avenue of Americas  
Newington NSW 2127  
Sydney, Australia  
Tel: 61 2 96483644  
Fax: 61 2 96483944

TTI Consulting Engineers(I) Pvt. Ltd,  
No.5, Shri Maruthi Chambers  
1<sup>st</sup> Main Road, Thimmalah Garden  
R.T. Nagar,  
Bangalore-560 032.  
Tel (+91) 80 26577922  
Fax:(+91) 80 23436022

TTI Consulting Engineers(I) Pvt Ltd,  
Delhi Project Office  
DJB Pumping Station  
Opp. Azad Bhawan, I.T.O  
New Delhi-110 002.  
Tel +91-11-23378736  
Fax: +91-11-23378489